

A...VRF Series



Application

- For supply and exhaust ventilation, air conditioning and heating.
- Mounting in false ceilings or walls.
- Used to arrange correct air circulation in premises.

Design

- Made of high quality plastic (ABS plastic or polystyrene).
- Special aerodynamic disk valve design ensures uniform air distribution.
- Smooth air pass regulation due to rotation of central part of the damper.
- Easy installation with fixing lugs and a mounting flange with a lock ring.
- The internal part has a sealing ring for more tight fit.

Grille modifications

A 80 VRF, A 100 VRF, A 125 VRF, A 150 VRF, A 200 RF - models with a mounting flange



- Equipped with a mounting flange and a lock ring for easy connection to round \varnothing 80/100/125 /150/200 mm air ducts.
- Mounting flange is fixed to false ceiling with screws.
- Lock ring provides easy fixing of the flexible air duct on a mounting flange.



A 200 VRF - double model with \varnothing 200 mm mounting flange



- Two regulating elements for more perfect air flow distribution.
- Equipped with a mounting flange and a lock ring for easy connection to round \varnothing 200 mm air ducts.
- Mounting flange is fixed to false ceiling with screws.
- Lock ring provides easy fixing of the flexible air duct on a mounting flange.



A 200/150 VRF - two-element model with a mounting flange



- Two regulating elements for more perfect air flow distribution.
- Equipped with a mounting reducing flange and a lock ring for easy connection to round \varnothing 150 mm air ducts.
- Mounting flange is fixed to false ceiling with screws.
- Lock ring provides easy fixing of the flexible air duct on a mounting flange.



Overall dimensions

Model	Dimensions, mm					Air pass, m ²	Damper normal pitch, mm	Fig. no.
	D	D1	D2	H	H1			
A 80 VRF	80	90	132	58	18	0...0,002	0...8	1
A 100 VRF	100	90	148	58	28	0...0,006	0...20	1
A 125 VRF	125	110	166	58	20	0...0,008	0...22	1
A 150 VRF	150	128	200	58	20	0...0,009	0...23	1
A 200 RF	200	183	246	58	20	0...0,009	0...16	1
A 200 VRF	200	128	246	58	20	0,001...0,008	0...19	2
A 200/150 VRF	150	128	246	82	20	0,001...0,008	0...19	3

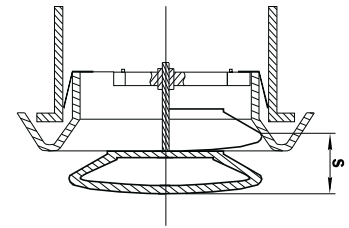

Fig. 4

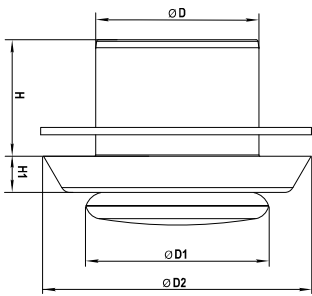

Fig. 1

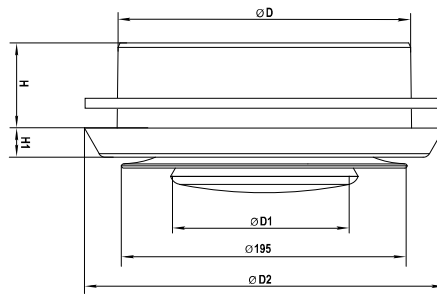

Fig. 2

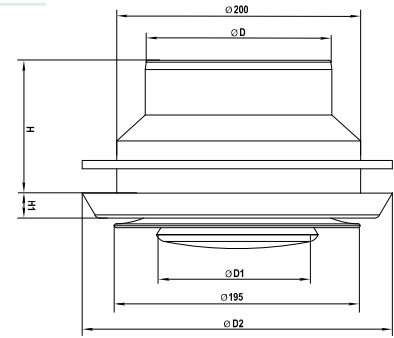
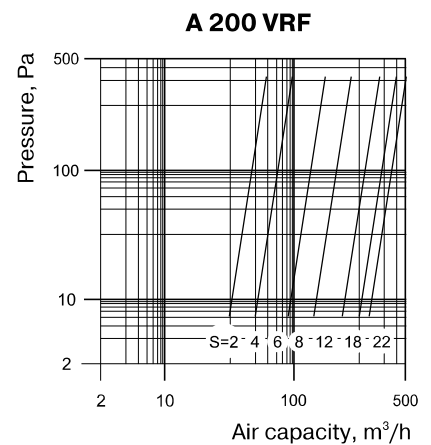
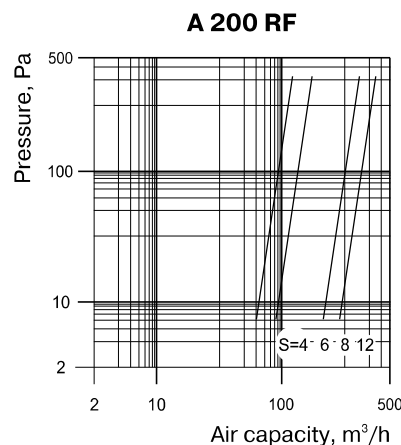
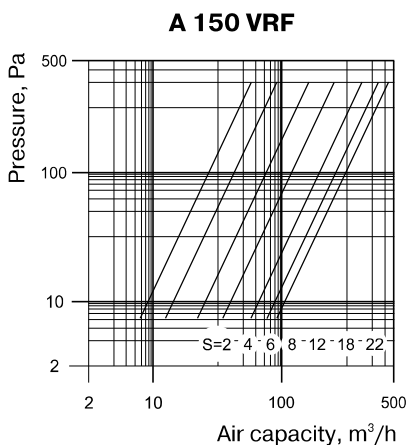
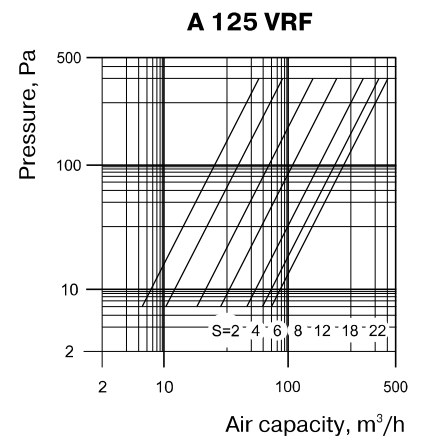
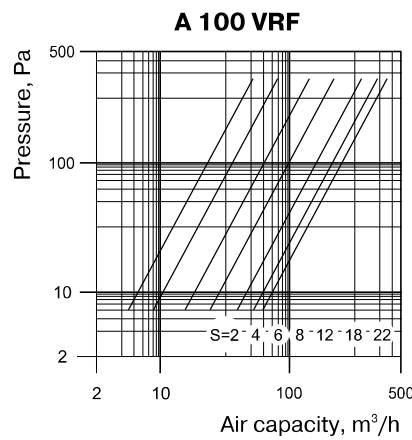
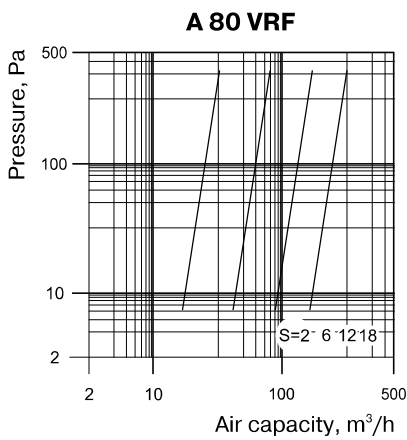

Fig. 3

Technical parameters



The internal part of the air disk valve is pulled out to ensure the required clearance S mm (fig. 4) to provide required air flow according to the diagram.