

Series  
**VENTS VUT EH**



LCD control panel

Air handling units with the air capacity up to **2200 m<sup>3</sup>/h** and recuperation efficiency up to 85% in sound-proof and heat-insulated casing with electric heater.

Series  
**VENTS VUT WH**



SA5908 control panel

Air handling units with the air capacity up to **2100 m<sup>3</sup>/h** and recuperation efficiency up to 78% in sound-proof and heat-insulated casing with water heater.

■ **Description**

Air handling units VUT EH with electric heater and VUT WH with water heater are the complete air handling units designed to provide both supply and exhaust ventilation with air filtering and heat recovery. The exhaust air energy is used to heat up the supply fresh air through the heat exchanger. All the models are designed for connection with Ø 125, 150, 160, 200, 250, 315 mm round ducts.

■ **Modifications**

**VUT EH** – a range of compact energy saving air handling units (AHU) equipped with supply and exhaust centrifugal fans, cross-flow heat recovery elements, electric heating coils and air filters.

**VUT WH** – a range of compact energy saving air handling units (AHU) equipped with supply and exhaust centrifugal fans, cross-flow heat recovery elements, water or glycol heating coils and air filters.

■ **Casing**

The casing is manufactured from aluminum-zinc compound with 25 mm thick mineral wool heat- and sound-insulating layer.

■ **Filter**

Two incorporated G4 panel filters for extract air ventilation and F7 filters for supply air ventilation are supplied with the unit.

■ **Fans**

The units are equipped with supply and exhaust centrifugal double-inlet fans with forward curved blades and built-in thermostat with automatic restart. The electric motors and impellers are dynamically balanced in two planes. The ball-bearings used with motors are designed for at least 40 000 hours operation and are maintenance-free.

■ **Heat exchanger**

The heat exchangers have high efficiency and are manufactured from aluminium plates. The unit is also equipped with the drain pan for condensate drainage.

■ **Heater**

If the external temperature is too low and/or the heat energy transfer from the extract air is insufficient to heat up the incoming air to the required temperature, the heater will automatically be turned on. The control system regulates the heating power to maintain the indoor temperature as set by the user. The units supplied with water heating coils are marked as VUT WH, and the units with electric heaters are marked as VUT EH. Water heating coils are available with two or four rows depending on required heating power.

■ **Automation and control system**

The unit is equipped with built-in automation system with multifunctional control panel with graphic LCD indicator. The standard delivery set includes 10 m wire for connection to the control panel. Electronic freezing protection is applied to prevent the heat exchanger freezing. It includes the by-pass damper and the heater. It operates due to opening of by-pass air shutter as the temperature sensor requires to let the air flow pass through the heat exchanger through the by-pass duct. During the heat exchanger defrost cycle the supplied air is warmed up in the heater up to the required temperature. During the defrost process the warm exhaust air warms the heat exchanger. After that the by-pass damper closes again, the heater is switched off, supply air warms up again through the heat exchanger and the unit continues operating under rated conditions.

■ **VUT EH control and protection functions**

- ▶ safe start-up and shutdown of the unit;
- ▶ setting and maintaining the desired temperature of the supply air with the control panel;
- ▶ motor speed control and regulation of the unit air capacity accordingly by means of the control panel;
- ▶ control of the external intake and exhaust air flow regulating damper actuators;

**Designation key:** \_\_\_\_\_

Series	Rated air capacity, m <sup>3</sup> /h	Heater type	Duct connection	Row number of the heater
<b>VENTS VUT</b>	350; 500; 530; 600; 800; 1000; 1500; 2000;	<b>E</b> – electric heater; <b>W</b> – water heater	<b>H</b> – horizontal duct connection	<b>2</b> – two rows; <b>4</b> – four rows

**Accessories**



page 242    page 242    page 282    page 296    page 298    page 307

**Offered options to the units**

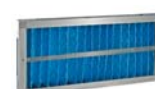

page 199

- ▶ working-out the required patterns while the unit start-up and shutdown;
- ▶ programming daily and weekly schedules by user;
- ▶ active electric heater overheating protection;
- ▶ disabling electric heater operation when the motor is not running;
- ▶ two electric heater over-heating thermostats;
- ▶ automatic switch ensuring the short circuit protection of the automation system;
- ▶ controlling filter clogging.

**VUT WH control and protection functions**

- ▶ safe start-up and shutdown of the unit;
- ▶ supply air temperature controlling by means of actuating three-way valve regulating the feed of the heat medium into the water coils;

- ▶ water (glycol) heating coils freezing protection as the leaving air temperature and leaving heat medium temperature sensors require;
- ▶ controlling the heat exchanger by-pass actuator;
- ▶ control of the external circulation pump operation installed on the heat medium feed line entering into the water coils;
- ▶ heat exchanger freezing protection;
- ▶ control of the intake and exhaust fan operation;
- ▶ air clogging control according to engine hours;
- ▶ control of the external intake and exhaust air flow regulating damper actuators.

Air handling unit is equipped with the remote control panel that provides:

- ▶ starting-up/shutdown of the ventilation unit;

- ▶ setting the required air flow;
- ▶ setting the required supply air temperature;
- ▶ displaying the temperature in the room.

**Mounting**

The air handling unit is mounted on the floor, suspended to the ceiling by means of a seat angle with inserted vibration-damping element or attached to a wall with brackets. The unit can be mounted either in service spaces or in main premises above the suspended ceiling, in the pocket or can be placed directly in the room. Mounting in any position shall provide the correct condensate drainage. Access for the unit maintenance and filter cleaning shall be provided through the side panels.

**Unit overall dimensions:**

Type	Dimensions, [mm]											
	∅D	B	B1	B2	B3	H	H1	H2	H3	L	L1	L2
VUT 350 EH	124	497	403	248	348	554	-	111	230	954	996	1054
VUT 500 EH	149	497	403	248	348	554	-	111	230	954	996	1054
VUT 530 EH	159	497	403	248	348	554	-	111	230	954	996	1054
VUT 600 EH	199	497	403	248	348	554	-	111	230	954	996	1054
VUT 800 EH	249	613	460	306	386	698	832	154	280	1071	1117	1171
VUT 800 WH	249	613	460	306	386	698	832	154	280	1071	1117	1171
VUT 1000 EH	249	613	460	306	386	698	832	154	280	1071	1117	1171
VUT 1000 WH	249	613	460	306	386	698	832	154	280	1071	1117	1171
VUT 1500 EH	314	842	581	320	520	814	947	201	595	1345	1388	1445
VUT 1500 WH	314	842	581	320	520	814	947	201	595	1345	1388	1445
VUT 2000 EH	314	842	581	320	520	814	947	201	595	1345	1388	1445
VUT 2000 WH	314	842	581	320	520	814	947	201	595	1345	1388	1445

**Accessories for air handling units:**

Type	Replaceable filter (panel filter) G4	Replaceable filter (panel filter) F7
VUT 350 EH	SF VUT 300-600 EH/WH G4	SF VUT 300-600 EH/WH F7
VUT 500 EH		
VUT 530 EH		
VUT 600 EH		
VUT 800 EH	SF VUT 1000 EH/WH G4	SF VUT 1000 EH/WH F7
VUT 1000 EH		
VUT 1500 EH	SF VUT 2000 EH/WH G4	SF VUT 2000 EH/WH F7
VUT 2000 EH		
VUT 800 WH-2	SF VUT 1000 EH/WH G4	SF VUT 1000 EH/WH F7
VUT 800 WH-4		
VUT 1000 WH-2		
VUT 1000 WH-4		
VUT 1500 WH-2	SF VUT 2000 EH/WH G4	SF VUT 2000 EH/WH F7
VUT 1500 WH-4		
VUT 2000 WH-2		
VUT 2000 WH-4		

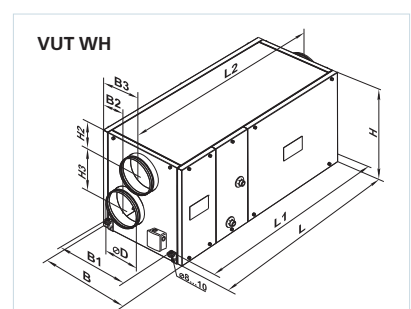
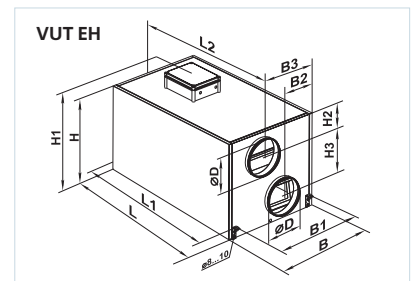

VENTS  
 AIR HANDLING UNIT WITH  
 HEAT RECOVERY SERIES  
 VUT EH / WH

# AIR HANDLING UNITS WITH HEAT RECOVERY

## Technical data:

	VUT 350 EH	VUT 500 EH	VUT 530 EH
Unit supply voltage [V / 50 Hz]	1~230	1~230	1~230
Maximum fan power [W]	2pcs. x 130	2pcs. x 150	2pcs. x 150
Fan current [A]	2pcs. x 0,60	2pcs. x 0,66	2pcs. x 0,66
Electric heater capacity [kW]	3	3	4
Electric heater current [A]	13	13	17,4
Number of water (glycol) coil rows	-	-	-
Total power of the unit [kW]	3,26	3,3	4,3
Total current of the unit [A]	14,2	14,32	18,72
Air capacity [m <sup>3</sup> /h]	350	500	530
RPM	1150	1100	1100
Noise level at 3m [dB(A)]	24-45	28-47	28-47
Operating temperature [°C]	-25 up to +55	-25 up to +50	-25 up to +50
Casing material	aluzink	aluzink	aluzink
Insulation	25 mm mineral wool	25 mm mineral wool	25 mm mineral wool
Filter: exhaust	G4	G4	G4
intake	F7 (EU7)	F7 (EU7)	F7 (EU7)
Duct connection diameter, [mm]	∅ 125	∅ 150	∅ 160
Weight, [kg]	45	49	49
Recuperation efficiency	up to 78%	up to 88%	up to 88%
Heat exchanger type	cross-flow type	cross-flow type	cross-flow type
Heat exchanger material	aluminum	aluminum	aluminum

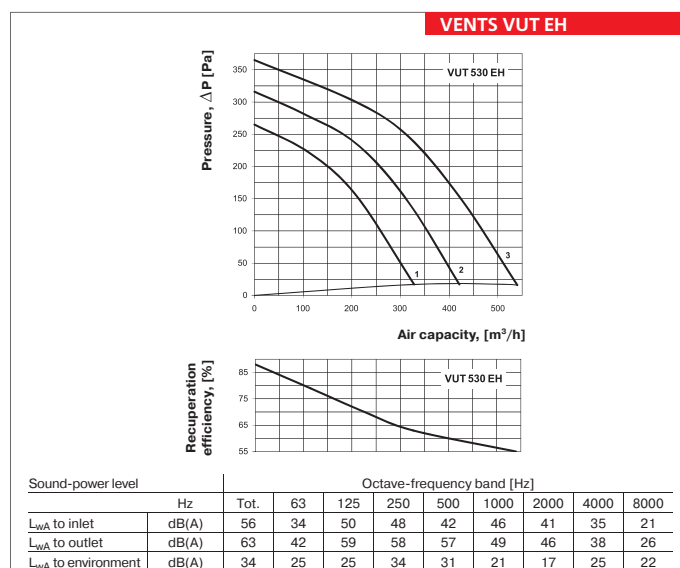
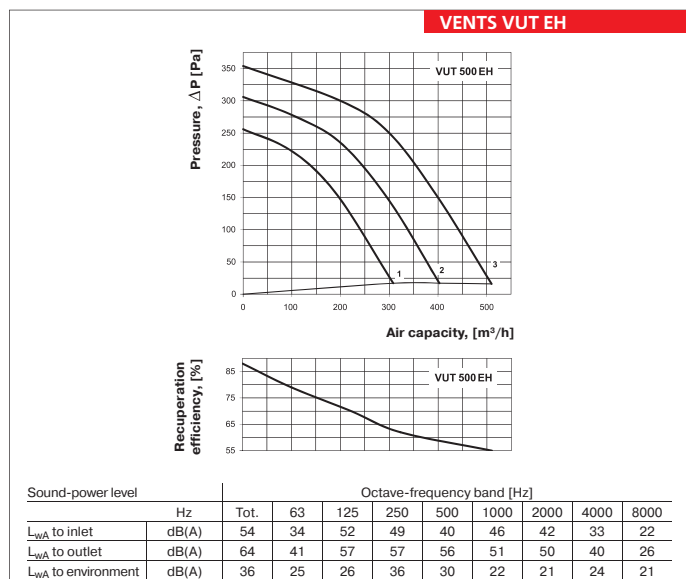
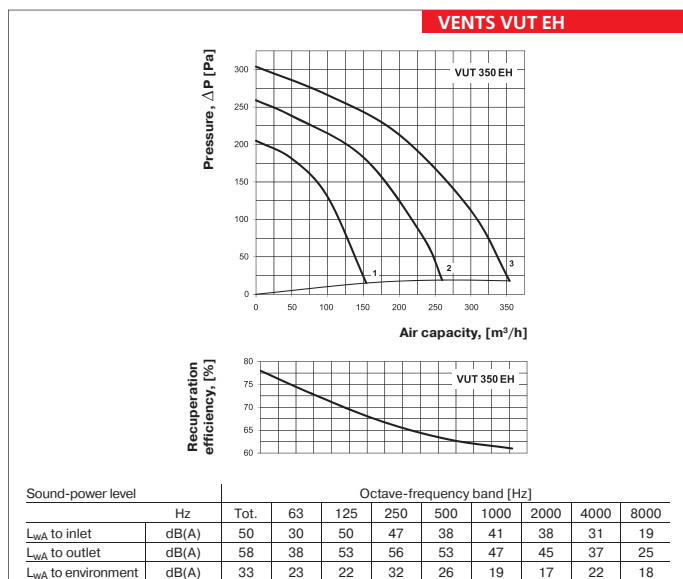

**Technical data:**

	VUT 600 EH	VUT 800 EH	VUT 800 WH-2 VUT 800 WH-4
Unit supply voltage [V / 50 Hz]	1~230	3~ 400	1~ 230
Maximum fan power [W]	2pcs. x 195		2pcs. x 245
Fan current [A]	2pcs. x 0,86		2pcs. x 1,08
Electric heater capacity [kW]	4	9,0	-
Electric heater current [A]	17,4	13,0	-
Number of water (glycol) coil rows	-	-	2 or 4
Total power of the unit [kW]	4,39	9,49	0,49
Total current of the unit [A]	19,1	15,16	2,16
Air capacity [m <sup>3</sup> /h]	600	800	780
RPM	1350		1650
Noise level at 3m [dB(A)]	32-48		48
Operating temperature [°C]	-25 up to +55		-25 up to +45
Casing material	aluzink		aluzink
Insulation	25 mm mineral wool		50 mm mineral wool
Filter: exhaust	G4		G4
intake	F7 (EU7)		G4 (F7)*
Duct connection diameter, [mm]	∅200		∅250
Weight, [kg]	54	85	88
Recuperation efficiency	up to 85%		up to 78%
Heat exchanger type	cross-flow type		cross-flow type
Heat exchanger material	aluminum		aluminum

\*option

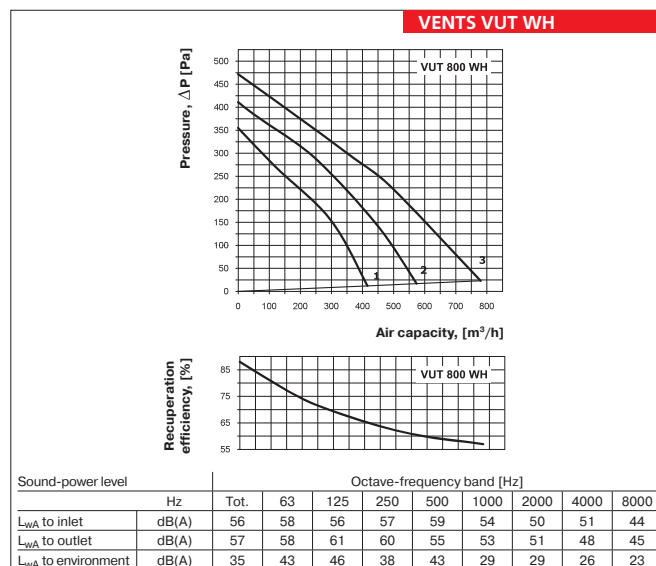
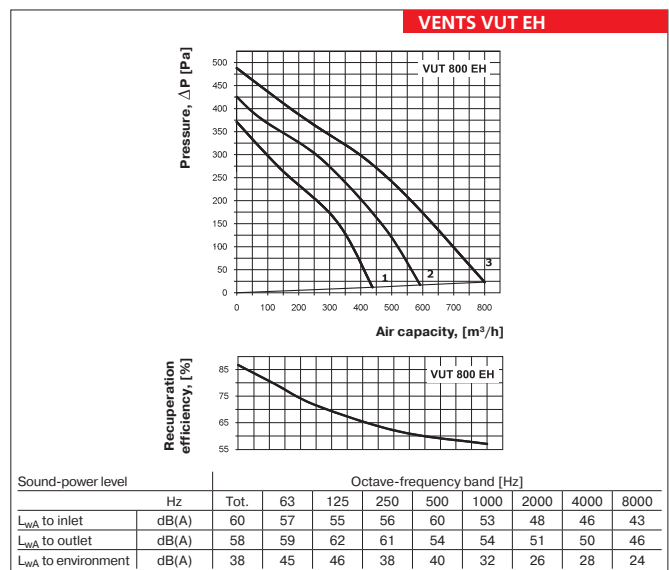
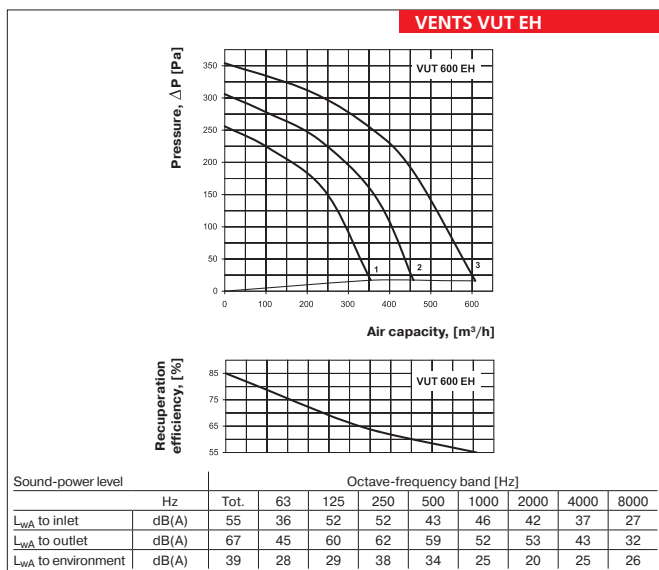

VENTS  
 AIR HANDLING UNIT WITH  
 HEAT RECOVERY SERIES  
 VUT EH / WH

# AIR HANDLING UNITS WITH HEAT RECOVERY

## Technical data:

	VUT 1000 EH	VUT 1000 WH-2 VUT 1000 WH-4	VUT 1500 EH
Unit supply voltage [V / 50 Hz]	3~400	1~230	3~ 400
Maximum fan power [W]		2pcs. x 410	2pcs. x 490
Fan current [A]		2pcs. x 1,8	2pcs. x 2,15
Electric heater capacity [kW]	9,0	-	18,0
Electric heater current [A]	13,0	-	26,0
Number of water (glycol) coil rows	-	2 or 4	-
Total power of the unit [kW]	9,80	0,82	18,98
Total current of the unit [A]	16,6	3,6	30,3
Air capacity [m <sup>3</sup> /h]	1200	1100	1750
RPM		1850	1100
Noise level at 3m [dB(A)]		60	49
Operating temperature [°C]		-25 up to +40	-25 up to +45
Casing material		aluzink	aluzink
Insulation		50 mm mineral wool	50 mm mineral wool
Filter: exhaust		G4	G4
intake		G4 (F7)*	G4 (F7)*
Duct connection diameter, [mm]		∅250	∅315
Weight, [kg]	85	88	96
Recuperation efficiency		up to 78%	up to 77%
Heat exchanger type		cross-flow type	cross-flow type
Heat exchanger material		aluminum	aluminum

\*option

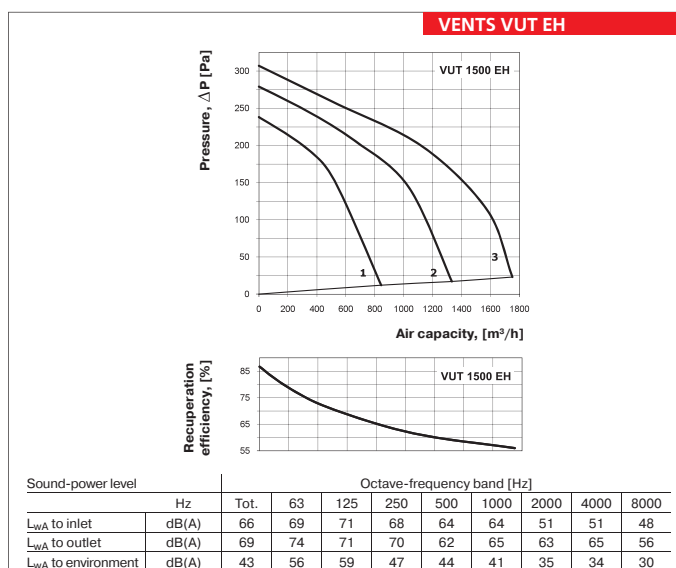
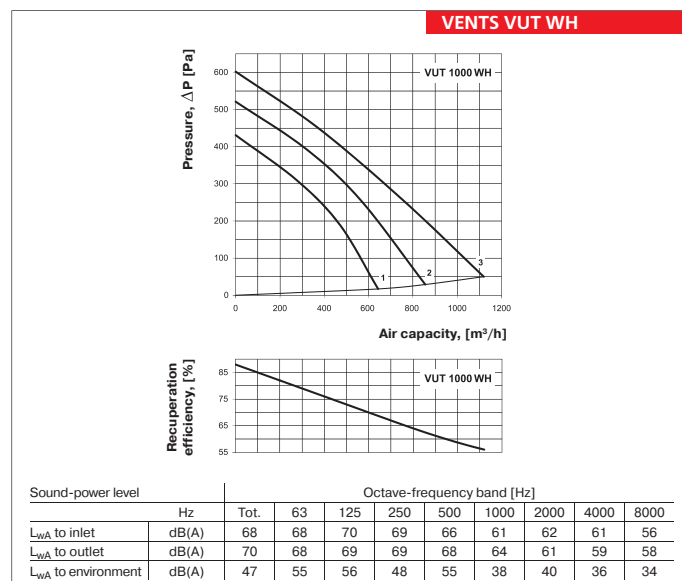
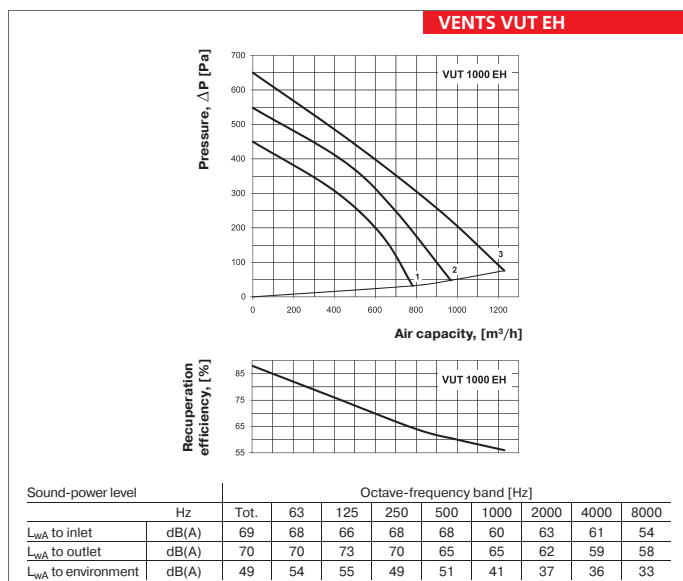

**Technical data:**

	VUT 1500 WH-2 VUT 1500 WH-4	VUT 2000 EH	VUT 2000 WH-2 VUT 2000 WH-4
Unit supply voltage [V / 50 Hz]	1~230	3~400	1~230
Maximum fan power [W]	2pcs. x 490		2pcs. x 650
Fan current [A]	2pcs. x 2,15		2pcs. x 2,84
Electric heater capacity [kW]	-	18,0	-
Electric heater current [A]	-	26,0	-
Number of water (glycol) coil rows	2 or 4	-	2 or 4
Total power of the unit [kW]	0,98	19,30	1,30
Total current of the unit [A]	4,3	31,7	5,68
Air capacity [m <sup>3</sup> /h]	1700	2200	2100
RPM	1100		1150
Noise level at 3m [dB(A)]	49		65
Operating temperature [°C]	-25 up to +45		-25 up to +40
Casing material	aluzink		aluzink
Insulation	50 mm mineral wool		50 mm mineral wool
Filter: exhaust	G4		G4
intake	G4 (F7)*		G4 (F7)*
Duct connection diameter, [mm]	∅315		∅315
Weight, [kg]	99	96	99
Recuperation efficiency	up to 77%		up to 77%
Heat exchanger type	cross-flow type		cross-flow type
Heat exchanger material	aluminum		aluminum

\*option

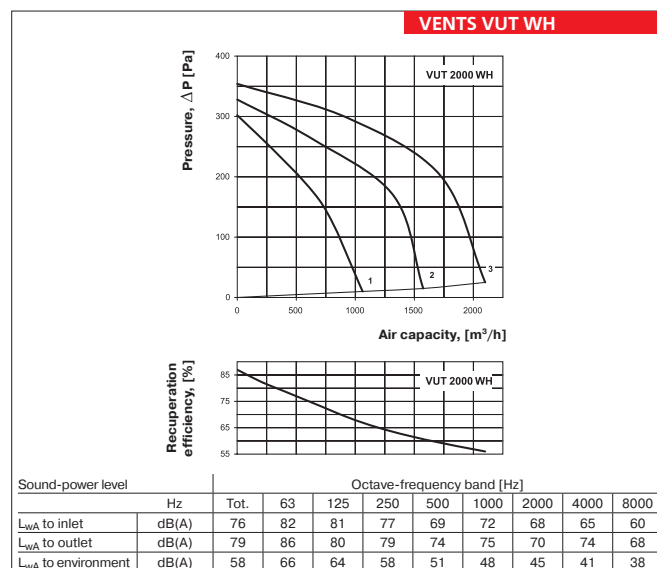
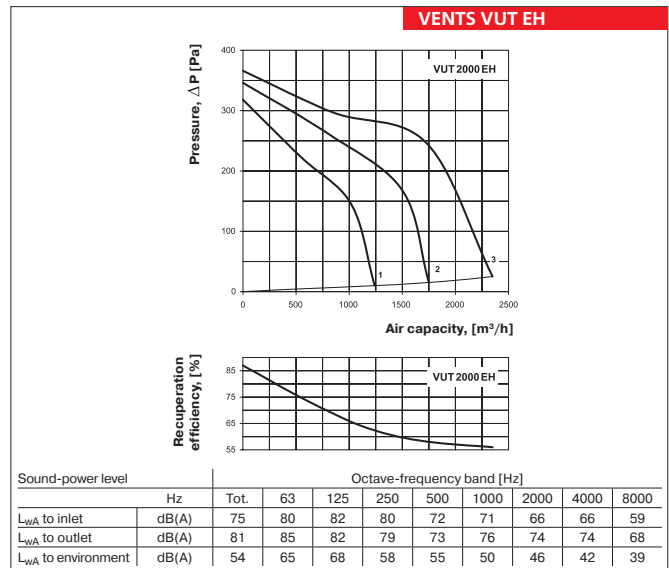
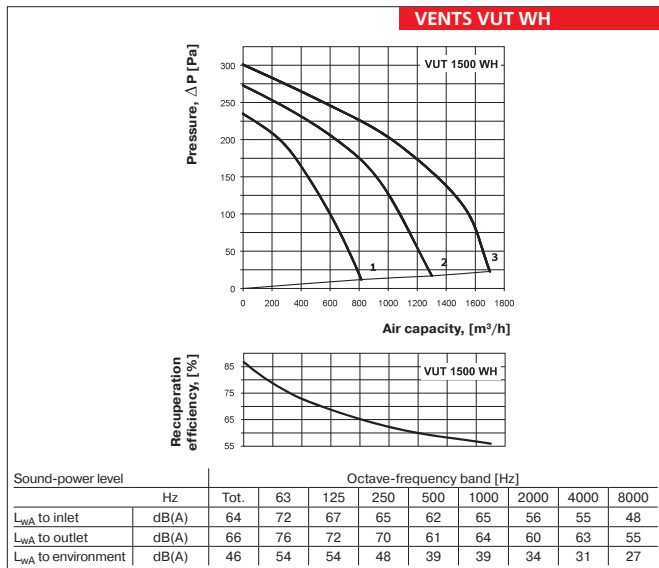

VENTS  
 AIR HANDLING UNIT WITH  
 VUT EH / WH  
 HEAT RECOVERY SERIES

Hot water coil parameters:

VENTS VUT WH

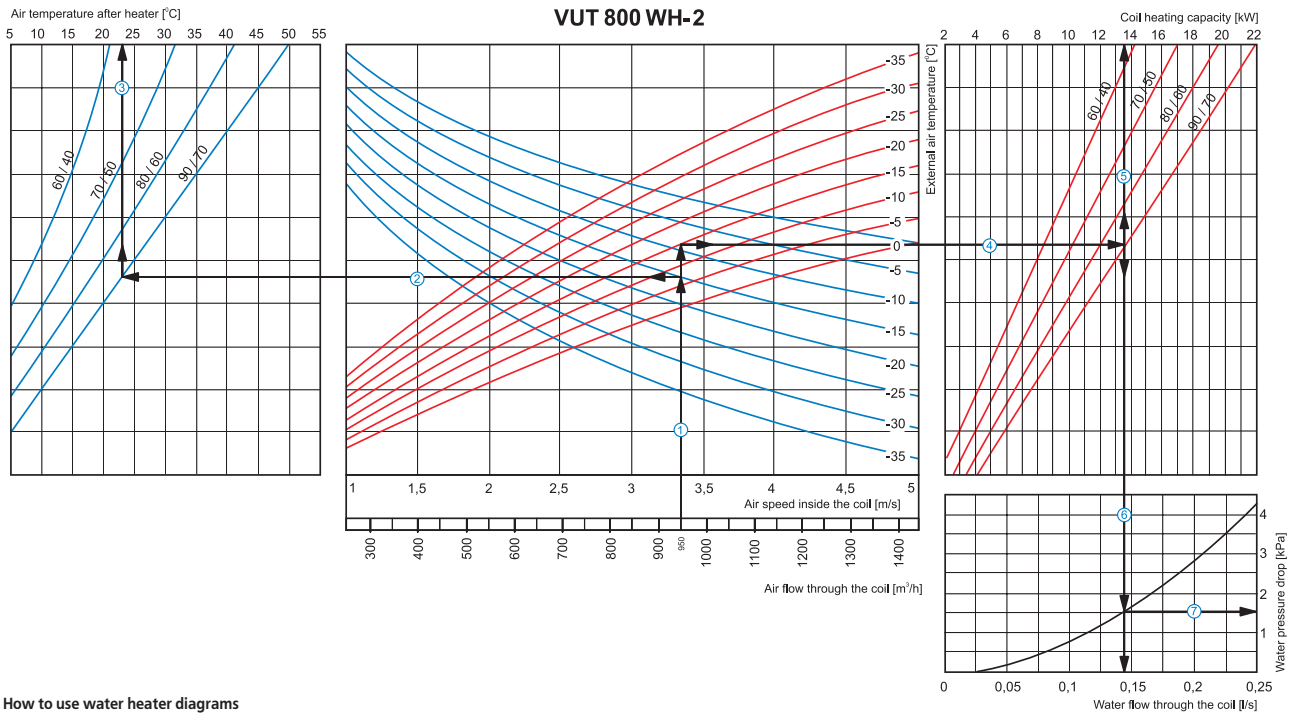

How to use water heater diagrams

System Parameters: Air flow = 950 m³/h. Outside air temper. = -15°C. Water temperature (in/out) = 90/70 °C

- Air Speed. Starting from 950 m³/h on the air flow scale draw a vertical line ① till the air speed axis which makes about 3.35 m/s.
- Supply air temperature. Prolong the line ① up to the point where it crosses the outside air temperature (blue curve, e.g. -15°C); then draw a horizontal line ② from this point to the left till crossing water in/out temperature curve (e.g. 90/70 °C). From this point draw a vertical line ③ to the supply air temperature axis on top of the graphic (+23°C).
- Heating coil capacity. Prolong the line ① up to the point where it crosses the outside air temperature (e.g. -15°C, red curve) and draw a horizontal line ④ from this point to the right until it crosses water in/out temperature curve (e.g., 90/70 °C), from here draw a vertical line ⑤ up to the scale representing the heating coil capacity (13.5 kW).
- Water flow. Prolong the line ⑤ down to water flow axis at the bottom of the graphic ⑥ (0.14 l/s).
- Water pressure drop. Draw the line ⑦ from the point where the line ⑥ crosses the black curve to the pressure drop axis. (1.5 kPa).

VENTS VUT WH

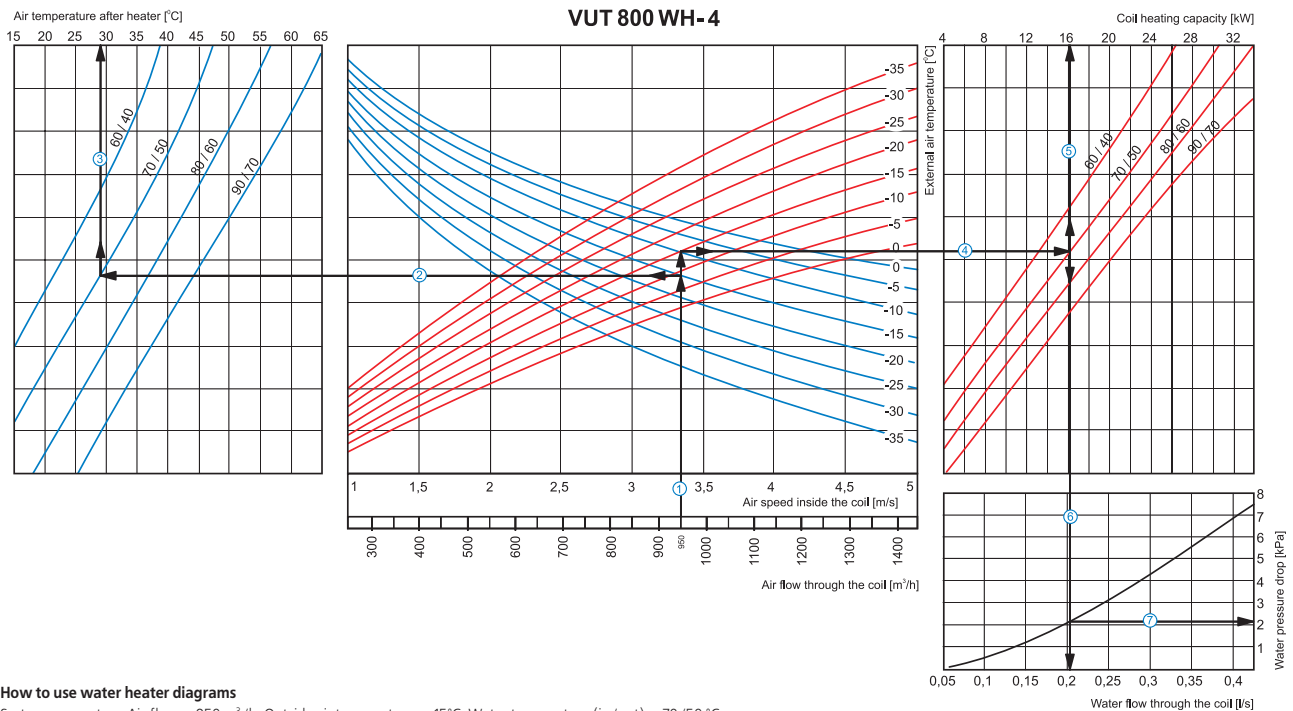

How to use water heater diagrams

System parameters: Air flow = 950 m³/h. Outside air temperature = -15°C. Water temperature (in/out) = 70/50 °C.

- Air Speed. Starting from 950 m³/h on the air flow scale draw a vertical line ① till the air speed axis which makes about 3.35 m/s.
- Supply air temperature. Prolong the line ① up to the point where it crosses the outside air temperature (blue curve, e.g. -15°C); then draw a horizontal line ② from this point to the left till crossing water in/out temperature curve (e.g. 70/50 °C). From this point draw a vertical line ③ to the supply air temperature axis on top of the graphic (+29°C).
- Heating coil capacity. Prolong the line ① up to the point where it crosses the outside air temperature (e.g. -15°C, red curve) and draw a horizontal line ④ from this point to the right until it crosses water in/out temperature curve (e.g., 70/50 °C), from here draw a vertical line ⑤ up to the scale representing the heating coil capacity (16.0 kW).
- Water flow. Prolong the line ⑤ down to water flow axis at the bottom of the graphic ⑥ (0.21 l/s).
- Water pressure drop. Draw the line ⑦ from the point where the line ⑥ crosses the black curve to the pressure drop axis. (2.1 kPa).

**Hot water coil parameters:**

**VENTS VUT WH**

**VUT 1000 WH-2**

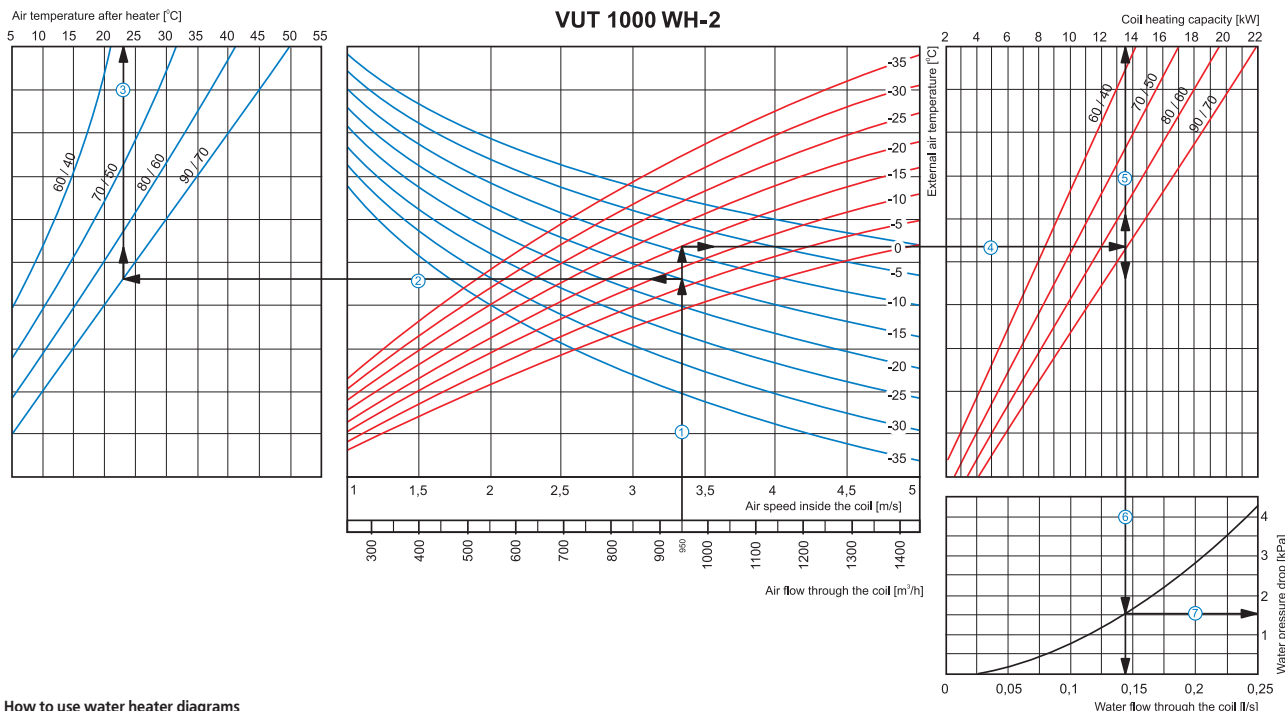

**How to use water heater diagrams**

System Parameters: Air flow = 950 m³/h. Outside air temper. = -15°C. Water temperature (in/out) = 90/70 °C

- Air Speed. Starting from 950 m³/h on the air flow scale draw a vertical line ① till the air speed axis which makes about 3.35 m/s.
- Supply air temperature. Prolong the line ① up to the point where it crosses the outside air temperature (blue curve, e.g. -15°C); then draw a horizontal line ② from this point to the left till crossing water in/out temperature curve (e.g. 90/70 °C). From this point draw a vertical line ③ to the supply air temperature axis on top of the graphic (+23°C).
- Heating coil capacity. Prolong the line ① up to the point where it crosses the outside air temperature (e.g. -15°C, red curve) and draw a horizontal line ④ from this point to the right until it crosses water in/out temperature curve (e.g., 90/70 °C), from here draw a vertical line ⑤ up to the scale representing the heating coil capacity (13.5 kW).
- Water flow. Prolong the line ⑤ down to water flow axis at the bottom of the graphic ⑥ (0.14 l/s).
- Water pressure drop. Draw the line ⑦ from the point where the line ⑥ crosses the black curve to the pressure drop axis. (1.5 kPa).

**VENTS VUT WH**

**VUT 1000 WH-4**

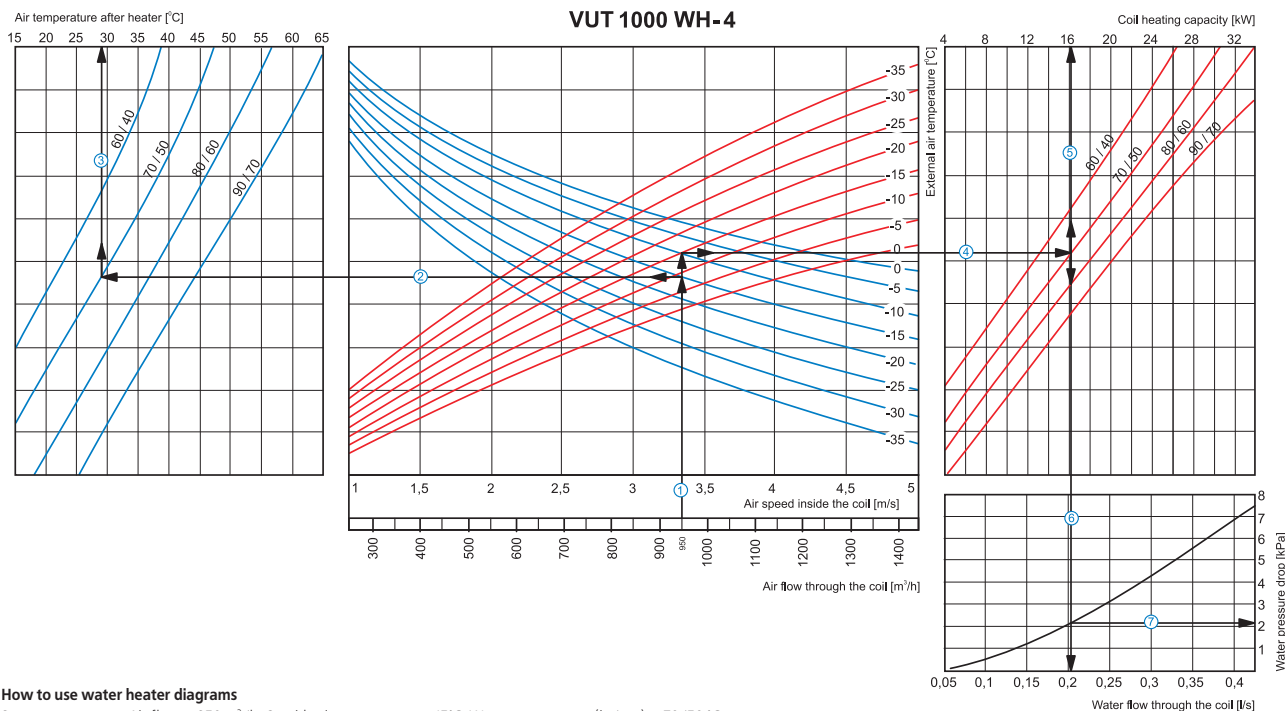

**How to use water heater diagrams**

System parameters: Air flow = 950 m³/h. Outside air temperature = -15°C. Water temperature (in/out) = 70/50 °C.

- Air Speed. Starting from 950 m³/h on the air flow scale draw a vertical line ① till the air speed axis which makes about 3.35 m/s.
- Supply air temperature. Prolong the line ① up to the point where it crosses the outside air temperature (blue curve, e.g. -15°C); then draw a horizontal line ② from this point to the left till crossing water in/out temperature curve (e.g. 70/50 °C). From this point draw a vertical line ③ to the supply air temperature axis on top of the graphic (+29°C).
- Heating coil capacity. Prolong the line ① up to the point where it crosses the outside air temperature (e.g. -15°C, red curve) and draw a horizontal line ④ from this point to the right until it crosses water in/out temperature curve (e.g., 70/50 °C), from here draw a vertical line ⑤ up to the scale representing the heating coil capacity (16.0 kW).
- Water flow. Prolong the line ⑤ down to water flow axis at the bottom of the graphic ⑥ (0.2 l/s).
- Water pressure drop. Draw the line ⑦ from the point where the line ⑥ crosses the black curve to the pressure drop axis. (2.1 kPa).

VENTS  
AIR HANDLING UNIT WITH  
HEAT RECOVERY SERIES  
VUT EH / WH



Hot water coil parameters:

VENTS VUT WH

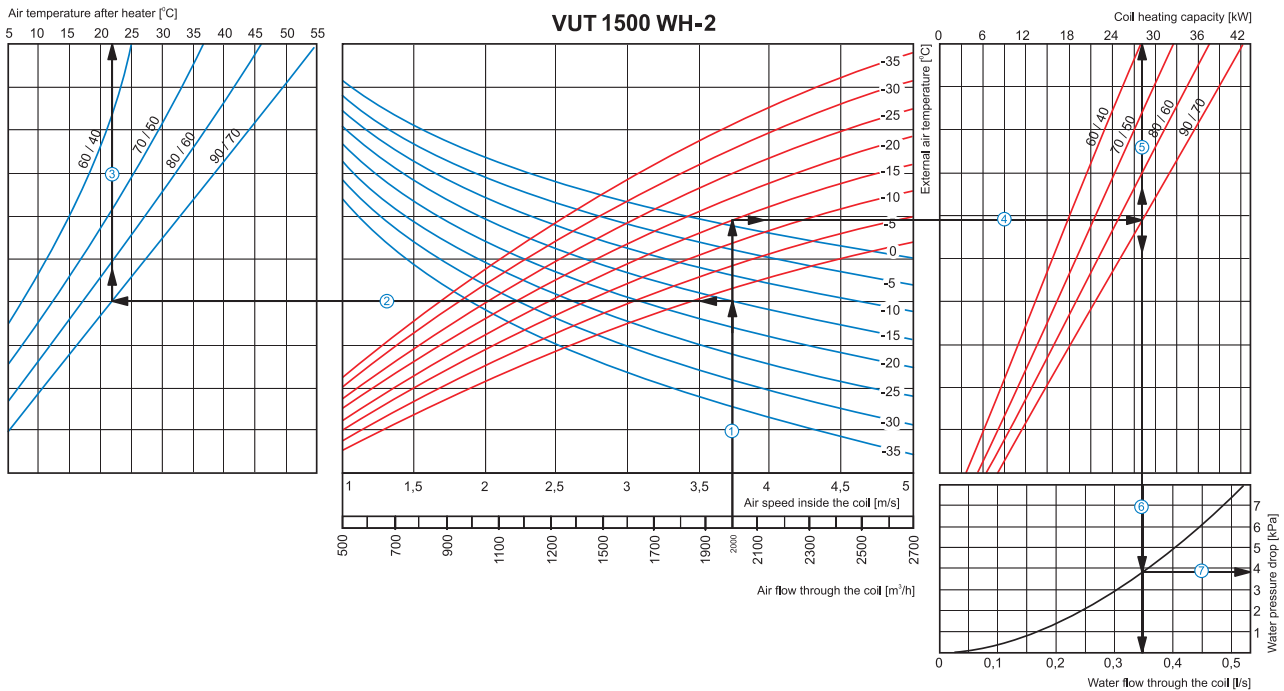

How to use water heater diagrams

System Parameters: Air flow = 2000 m<sup>3</sup>/h. Outside air temperature = -15°C. Water temperature (in/out) = 90/70 °C.

- Air Speed. Starting from 2000 m<sup>3</sup>/h on the air flow scale draw a vertical line ① till the air speed axis. (3.75 m/s).
- Supply air temperature. prolong the line ① up to the point where it crosses the outside air temperature (blue curve, e.g. -15°C); then draw a horizontal line ② from this point to the left till crossing water in/out temperature curve (e.g. 90/70 °C). From this point draw a vertical line ③ up to the supply air temperature axis on top of the graphic (+22°C).
- Heating coil capacity. Prolong the line ① up to the point where it crosses the outside air temperature (e.g. -15°C, red curve) and draw a horizontal line ④ from this point to the right until it crosses water in/out temperature curve (e.g., 90/70 °C), from here draw a vertical line ⑤ up to the scale representing the heating coil capacity (28.0 kW).
- Water flow. Prolong the line ⑤ down to water flow axis at the bottom of the graphic ⑥ (0.35 l/s).
- Water pressure drop. Draw the line ⑦ from the point where the line ⑥ crosses the black curve to the pressure drop axis. (3.8 kPa).

VENTS VUT WH

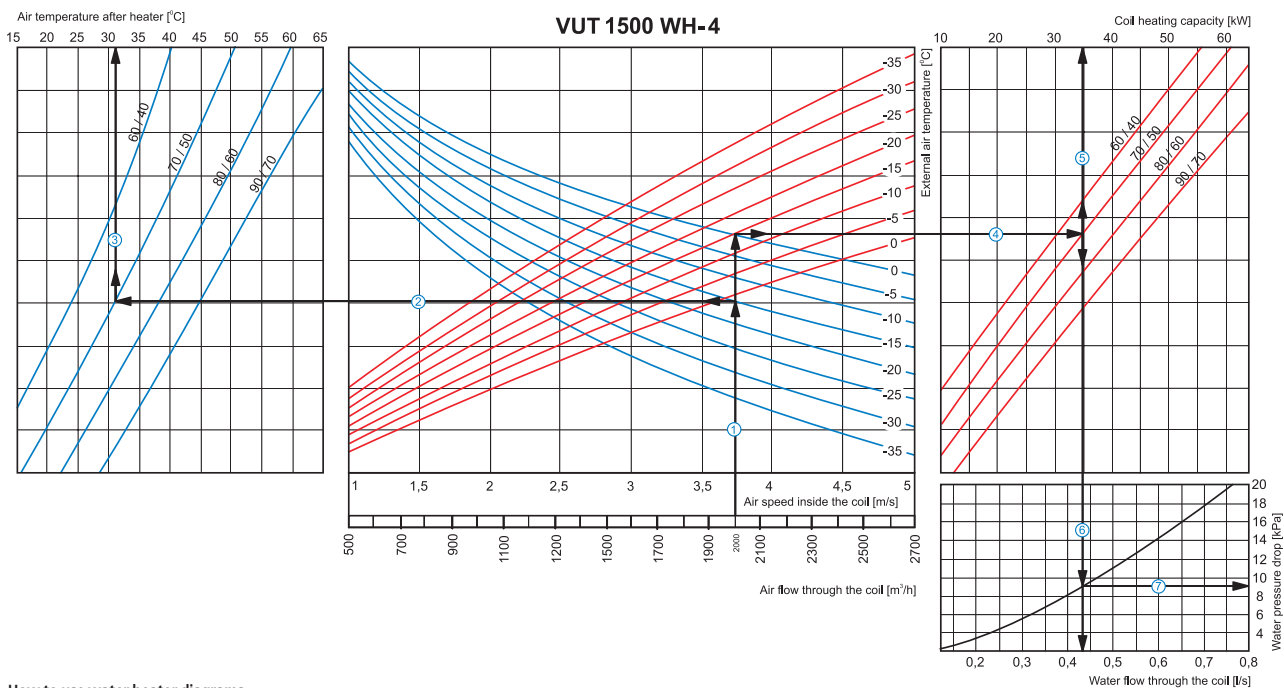

How to use water heater diagrams

System Parameters: Air flow = 2000 m<sup>3</sup>/h. Outside air temperature = -15°C. Water temperature (in/out) = 70/50 °C.

- Air Speed. Starting from 2000 m<sup>3</sup>/h on the air flow scale draw a vertical line ① till the air speed axis which makes about 3.75 m/s.
- Supply air temperature. prolong the line ① up to the point where it crosses the outside air temperature (blue curve, e.g. -15°C); then draw a horizontal line ② from this point to the left till crossing water in/out temperature curve (e.g. 70/50 °C). From this point draw a vertical line ③ up to the supply air temperature axis on top of the graphic (+31°C).
- Heating coil capacity. Prolong the line ① up to the point where it crosses the outside air temperature (e.g. -15°C, red curve) and draw a horizontal line ④ from this point to the right until it crosses water in/out temperature curve (e.g., 70/50 °C), from here draw a vertical line ⑤ up to the scale representing the heating coil capacity (35.0 kW).
- Water flow. Prolong the line ⑤ down to water flow axis at the bottom of the graphic ⑥ (0.43 l/s).
- Water pressure drop. Draw the line ⑦ from the point where the line ⑥ crosses the black curve to the pressure drop axis. (9.0 kPa).

**Hot water coil parameters:**

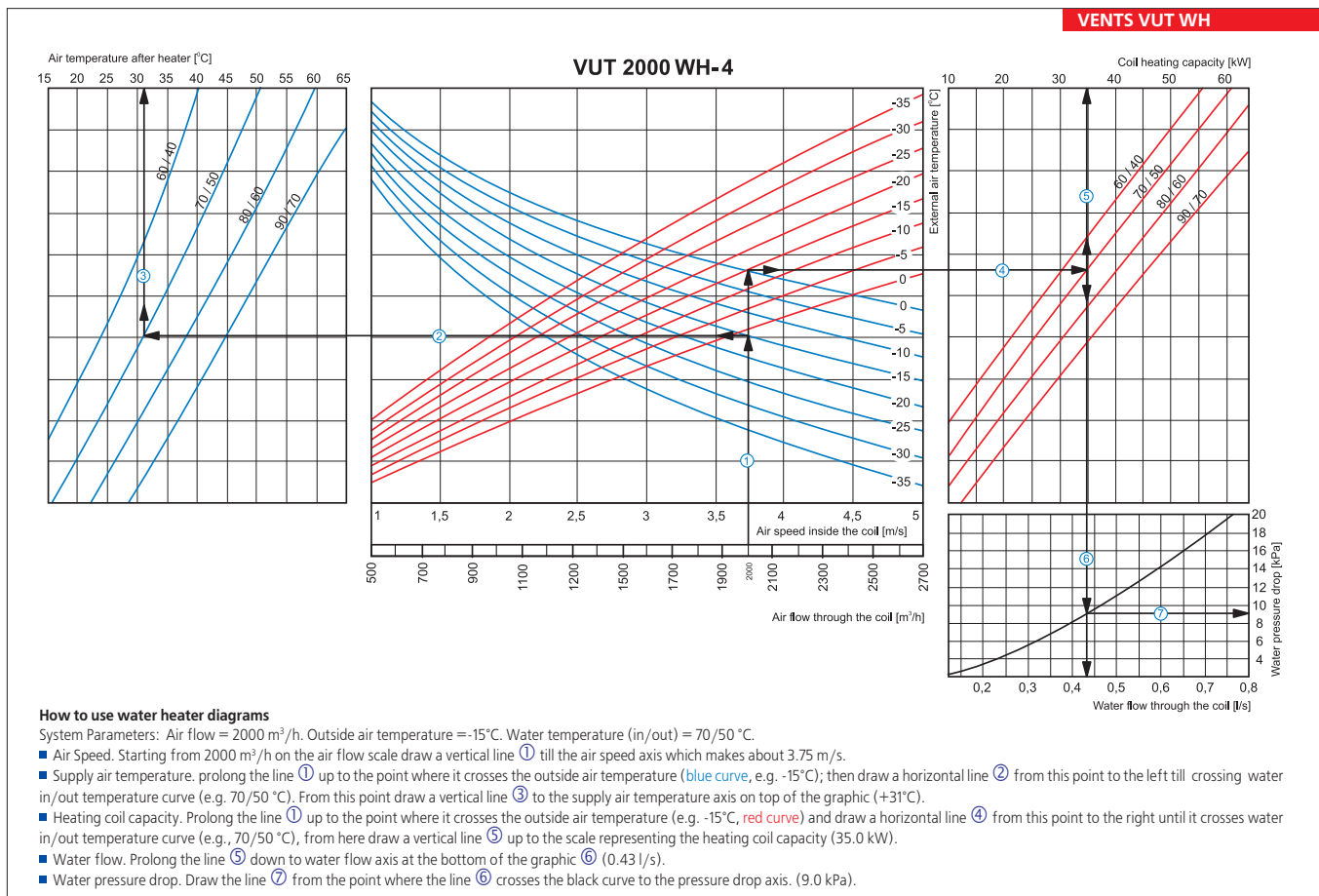
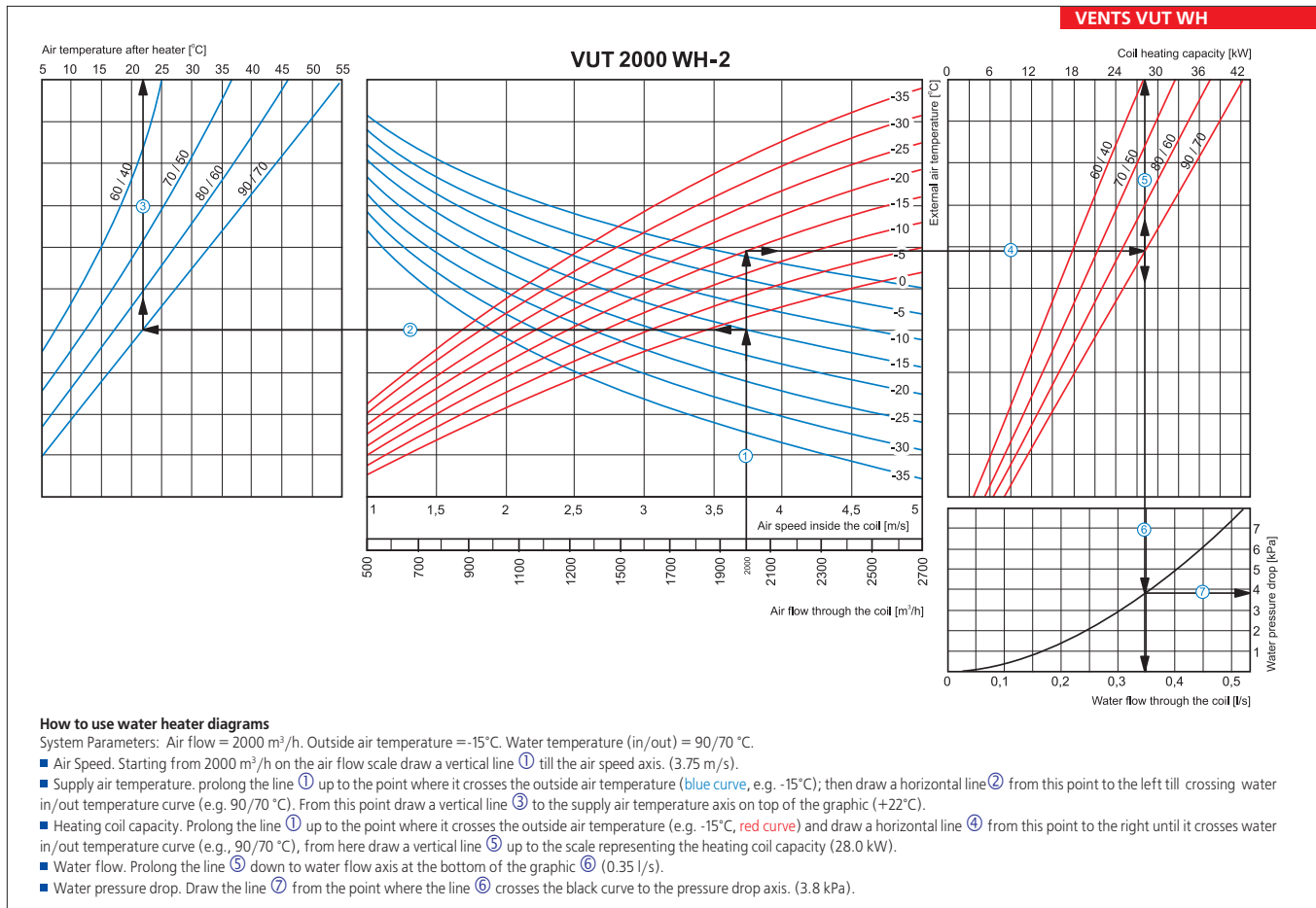

VENTS  
 AIR HANDLING UNIT WITH  
 HEAT RECOVERY SERIES  
 VUT EH / WH